

Finite Temperature Quantum Memory and Haah's Code

S.M. Kravec¹

¹*Department of Physics, University of California at San Diego, La Jolla, CA 92093*

This paper addresses the question of whether realizations of topological order, such as Kitaev's toric code, can realize stable quantum memory at finite temperature. I also describe a solvable lattice model, with a very unique realization of topological order, which may accomplish this.

MEMORY LANE

One of the more exciting potential applications of topological phases is in quantum computing and information science. First proposed by Kitaev,[12] it may be possible to implement the unitary transformations of a quantum algorithm by the 'braiding' of *non-abelian* anyons.¹ These are proposed to exist in the $\nu = \frac{5}{2}$ Hall state.[3]

The state of the system is stored in the highly degenerate groundspace of a topologically ordered phase. An exemplary feature of topological order is that this groundspace is symmetry preserving and the degeneracy depends on the topology of space-time. Focusing on the simpler case of abelian topological order, like the $\nu = \frac{1}{q}$ Hall states, it is possible one could implement a robust quantum *memory*.[8]

What is this robustness? In analogy to classical memory one stores the value of a bit in the magnetization of some spins: $\langle m \rangle$. It's possible that several spins could flip but it is energetically unlikely for the overall sign to flip; there's a redundant encoding of the memory.

Similarly the topological nature of the groundstates provides a redundancy by virtue of the fact they are locally indistinguishable. What I mean is that if you computed the reduced density matrix, on some topologically trivial region of the space-time, you will get the same result independent of which of the groundstates you used. This implies the state of the system is robust to local perturbation.[18]

However at finite temperature the story is different. Our simplest $d = 2$ models², such as Kitaev's toric code or it's generalization to quantum double models, are not robust to the percolation of defects.[1] This poses a challenge for physical applications and a theoretical question: are there examples of topological order that are stable for $T > 0$?

In this paper I'd like to discuss how one arrives at these conclusions for the toric code in d spatial dimensions. In these examples, and many others, one can understand the topological order as an emergent discrete gauge theory. In attempting to address the question of stability at finite temperature a $d = 3$ model, known as Haah's cubic code, was introduced.[9] This model does not obviously have a gauge theory description and has many strange properties which I shall highlight.

MELTING \mathbb{Z}_2 GAUGE THEORY

A defining characteristic of topological order is a finite universal contribution to the entanglement entropy:

$$S(A) = \alpha |\partial A| - \gamma \quad (1)$$

where the leading contribution arises from the 'area' law and γ is the topological entanglement entropy.³ For the zero temperature toric code $\gamma = \log 2$. [14] In practice this quantity is used as one way to detect topological order in computer simulations of spin liquids[20] so it would be good to understand how this evolves as one heats up the system.

Calculating **1** explicitly, at finite size N , one finds that the topological contribution is halved in region between two critical temperatures.[7] Beyond that the contribution vanishes exactly as in Figure **1**.

This intermediate phase exists when one of the coefficients is much larger than the other; Δ is proportional to their difference. Because of this difference, magnetic defects proliferate but the electric defects are still more expensive. This permits, in some basis, phase errors to accumulate in the qubits encoded in the degenerate groundspace. In this temperature regime one can realize a protected classical memory.

¹ Similar proposals exist using the vortices/defects of SPT phases such as the $p + ip$ superconductor

² See the appendix for a review of the toric code model

³ See the appendix for a quick review of entanglement entropy from a field theory POV

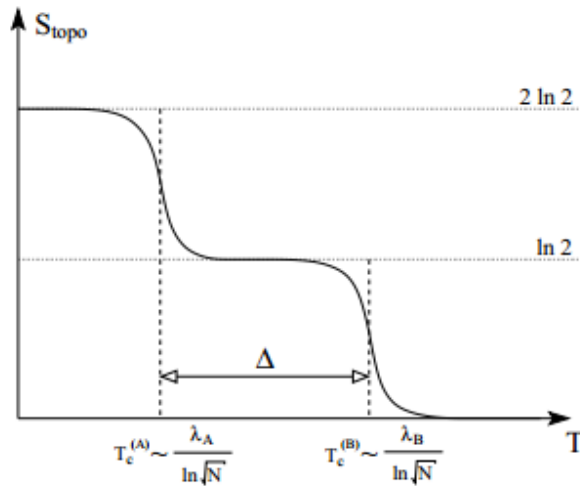

FIG. 1: Temperature dependence of $S_{topo} \equiv 2\gamma$ where $\lambda_B \gg \lambda_A$

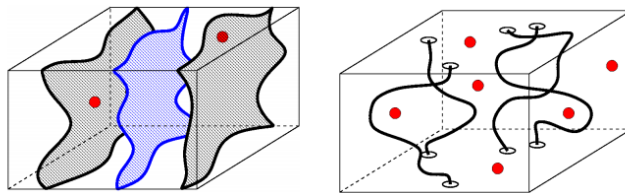

FIG. 2: On the left are membrane operators associated with B_p in the $d = 3$ toric code. One of these operators wound around a defect cannot be continuously deformed into a membrane with no winding. This is contrasted to the string operators on the right.

Another thing to notice is that the critical temperatures $T_c \propto \frac{1}{\log N}$ meaning that in the thermodynamic limit, at any finite temperature, the topological contribution exactly vanishes.

The story in higher dimensions is somewhat different. It is a basic fact of topology that $\pi_1(\mathbb{R}^{n \geq 3} - 0) = \mathbb{Z}_1$ which translated says that the winding of strings around point-like defects is always trivial; one can continuously deform the string so that it never winds. Does this translate into a more robust quantum memory?

Almost. Note that the plaquette operator of the toric code in $d = 2$ are now 'volume' operators in $d = 3$; they act on all the links on the boundary of some cube. This geometric difference means that excitations are no longer hosted at the ends of strings but are the boundary of a whole membrane! These objects suffer the same issues as the string operators in $d = 2$. See figure 2 for a cartoon of this distinction.

Because of the difference of these operators however there is a phase, similar to the intermediate region in 1, which realizes a robust classical memory even in the thermodynamic limit. This result can also be seen by direct computation of the topological entanglement entropy at finite temperature.

For $d \geq 4$ there's more freedom. In particular one can allow both the electric and magnetic operators to be membranes, which are now robust as string operators were in $d = 3$. This realization of the toric code⁴ is the first to have a stable quantum memory up to a critical temperature.[8]

Further calculations of the entanglement entropy for the more general toric code models was done in [15] in arbitrary dimensions confirm these results. Another demonstration of the instability of topological order in toric code like models at finite T was done in [16] by showing the expectation value of string operators in the theory vanish.

A recent work suggests that for some dimensions the temperature at which defects percolate may be smaller than the actual critical temperature when quantum memory becomes unfeasible.[10]

⁴ Which is a 2-form \mathbb{Z}_2 gauge theory

HAAH'S CUBIC CODE

Motivated by the above results, and a more general no-go theorem about the use of $d = 2$ models which are made of commuting projectors[6], one may try to construct a model which realizes a topological order in $d = 3$ which is more robust.

Consider a system of two qubits on the sites of a L^3 hypercubic lattice. We define the Hamiltonian of the cubic code as:

$$\hat{H} = -J \sum_c (G_c^X + G_c^Z) \quad (2)$$

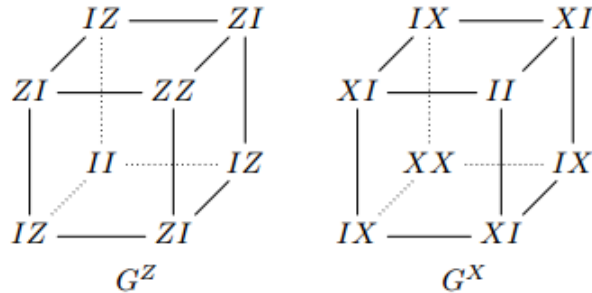

FIG. 3: The G operators of 2 acting on the vertices of a cube. Tensor products between operators suppressed.

where the sum runs over cubes and the G -operators are defined graphically as in Figure 3. These operators are commuting and a groundstate of the system is where both operators yield 1. While 3 define a very peculiar spin interaction⁵ 2 is nevertheless translation invariant and local in its interactions.

One of the most dramatic departures from other models of topological order is in the number of groundstates. The cubic code is highly degenerate increasing in the system size as $g = 2^{k(L)}$ for $2 \leq k(L) \leq 4L$. These are all locally indistinguishable.⁶

A general formula for $k(L)$ is not known and it can depend dramatically on the size of the system. For example $k(L) = 2$ for any odd $3 \leq L \leq 200$ such that L is not a multiple of 15 or 63.⁷

Another strange feature of this model is that the entanglement entropy has a subleading contribution which is *extensive* and growing linearly in L . It also cannot be cancelled like the area law contribution by choosing linear combinations of regions. [11]

Excited states are simply those for which one of the G -operators yields -1 and they are pointlike. However if one imagines creating such a defect by means of local operators one creates a wake of other defects in neighboring cubes. For example acting $X \otimes \mathbb{1}$ on the qubits at site i creates 4 defects, violations of G^Z , on some of nearest neighbor cubes. These then create an additional set of errors and the process goes on.

Using this one can determine that excitations are highly confined and attempting to create and move an excitation costs energy growing logarithmically in the length of the path.[5] In fact one can derive a recursive formula which describes the patterns of auxiliary defects which appear; they are supported by fractals not strings like in the toric code. There is even an exact mapping to one of the recently constructed fractal models in [19].

These features are not unrelated. The no-go theorem of [18] relates the existence string-like operators in $d = 3$ topologically ordered models to a groundstate degeneracy independent of system size.

One may ask, given this complicated space of groundstates and fractal operators relating them how can one perform quantum memory manipulation? A scheme was developed to encode information and detect errors relying on the algebraic formalism of code theory and the real space RG of the cubic code. Numerical calculations implemented this scheme and computed the time scales for which memory could be maintained.[4]

⁵ It was discovered algebraically using code theory machinery

⁶ Any operator with compact support on a cube of length $< L$ is proportional to identity when acting on the space of groundstates

⁷ What the fuck

SUMMARY

Topological order is an exotic property of matter which may be relevant for quantum computing technology. As we've seen our most simple models have instabilities at finite temperature. In attempting to address this problem, and understand the underlying physics, a set of very peculiar models have been constructed which may not have well defined continuum limits. Understanding the consequences this has and properties they share may give us a better definition of topological order and perhaps even what physics field theory can describe.

Acknowledgments I would like to thank Prof. McGreevy for offering this course and for his efforts to teach me physics. I'd also like to thank Brian Swingle for discussions which motivated me to write on this topic.

APPENDIX: THE TORIC CODE

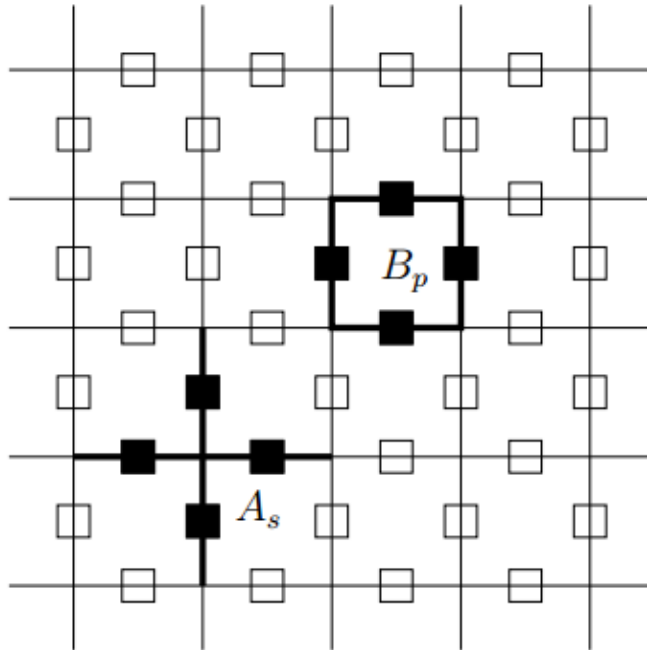

FIG. 4: Toric code operators defined on the square lattice

I'd like to review a simple solvable model whose groundstates realize a deconfined \mathbb{Z}_2 gauge theory.[13]

Let us begin with the square lattice⁸ in $d = 2$ where the degrees of freedom, a simple spin- $\frac{1}{2}$, live on the links of the lattice. The Hamiltonian can be defined graphically, with reference to figure 4, as the following:

$$\hat{H} = -\lambda_A \sum_s A_s - \lambda_B \sum_p B_p \quad (3)$$

where s labels sites of the lattice and p labels different plaquettes. The operators A_s and B_p are projectors built from Pauli operators as:

$$A_s \equiv \prod_{i \in v(s)} X_i \quad B_p \equiv \prod_{l \in \partial p} Z_l \quad (4)$$

⁸ Though it may be defined on any graph

where these products give four Pauli's associated with links like in figure 4. As promised 3 defines a solvable model as $[A_s, A_{s'}] = [A_s, B_p] = [B_p, B_{p'}] = 0$ which is easily checked. This allows us to diagonalize these operators simultaneously and understand the groundstates as those $|\psi\rangle$ for which $A_s|\psi\rangle = |\psi\rangle$ and $B_p|\psi\rangle = |\psi\rangle$ for all s and p .

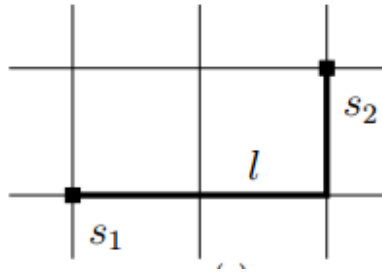

FIG. 5: Two excitations at s_1 and s_2 supported by a 'string' of down spins colored black. Note the intermediate vertices have only even numbers of down spins.

Let's focus on the A_s operator first in the x -basis. The spins on each link can be up or down giving ± 1 each. Overall $A_s = 1$ only when there is an even number of down spins. One way to visualize this condition is to color every link with a down spin as in figure 5

For any given vertex the configurations which cost energy are those with a single unpaired link and moving beyond one vertex you could say that a 'string' of these colored links terminates there. This is the source for people labelling the toric code as a 'string-net' model.

From this we infer that the space of groundstates has only closed strings. What about the operator B_p ? In the x -basis it simply flips all the spins on a given plaquette. If all spins are up it creates a closed string and if there's a string present it moves it at no cost of energy.

That $B_p = 1$ for a given plaquette we say indicates the absence of a vortex on that plaquette. This condition is equivalent to $A_s = 1$ only on the dual lattice and in the z -basis.

Because of the closed string condition of the groundstates, and the no energy cost of creating/removing closed loops or moving existing, the groundstates are equal superpositions of string configurations related by actions of the B_p operators.

The story however is not complete. So far I haven't spoken of the boundary conditions on the lattice. If one takes periodic boundary conditions, equivalent to embedding the lattice in a torus, then there are allowed sting configurations which are not the result of some action of B_p . These are the non-trivial winds around the torus.

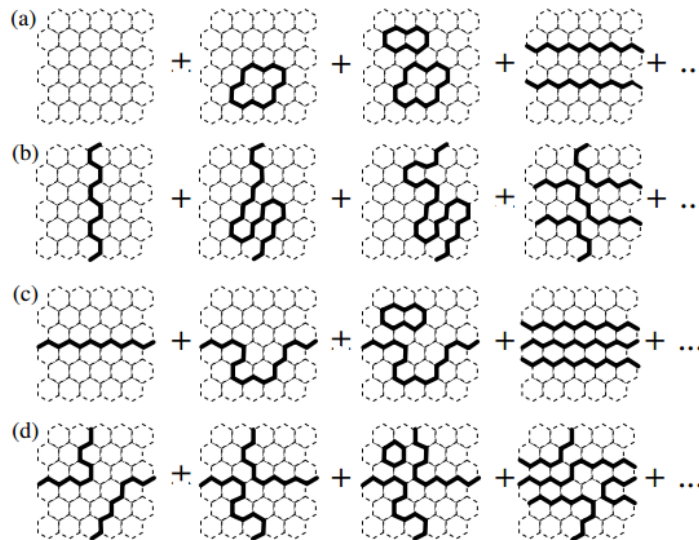

FIG. 6: Each letter represents a different groundstate, sums of spin configurations, of the toric code on the hexagonal lattice. a has no non-trivial loops, b and c each have one in different directions, d has both.

For the toric code on the 2-torus this implies there are 2^2 groundstates each labelled by the presence or absence of non-trivial strings as in figure 6. Note that two strings making the same non-trivial wind are equivalent to no string by the action of B_p . [17] In the language of simplicial homology the space of groundstates forms a representation of $H^1[\mathbb{T}^2, \mathbb{Z}_2] \cong \mathbb{Z}_2 \times \mathbb{Z}_2$, the first homology group of the 2-torus with \mathbb{Z}_2 coefficient ring.

The effective theory of the groundstates is \mathbb{Z}_2 gauge theory on the lattice where the local gauge redundancy is the action of flipping all spins around a plaquette or vertex. Note that an open string would not be a gauge invariant observable in this theory.

The theory is easily generalized to higher dimensions by letting the products in 4 to range over different p -cells. A 0-cell is a vertex, a 1-cell is a link, 2-cell is a plaquette, and so on. The $d = 2$ toric code has both operators a product over 1-cells. The $d = 3$ toric code still has the A_s term a product over 1-cells but now the B_p term is a product over 2-cells which are the boundaries of 3-cells. In $d = 4$ there is the possibility where both products are over 2-cells.

The excitations of 3, as seen in figure 5, are supported on the ends of strings. There are then two associated string operators $W_C^e = \prod_{l \in C} Z_l$ and $W_C^m = \prod_{l \in C} X_l$ for electric and magnetic excitations respectively. C denotes a curve on the lattice while \bar{C} is a curve on the dual lattice.

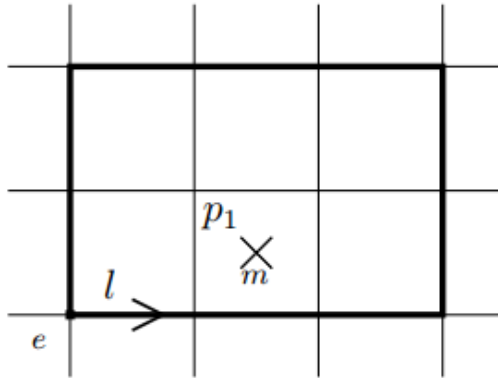

FIG. 7: The electric charge is created and wound with W_C^e on the black line. This is contractibly equivalent to just B_p on the plaquette with the vortex.

Note that $W_C^e = B_p$ when the curve C is the boundary of the plaquette p . Using this fact one can infer that the electric and magnetic excitations are mutual fermions. The statistics can be extracted by winding an electric charge around a plaquette with a magnetic vortex seen in figure 7. This reduces to the action of B_p on this plaquette which by assumption must yield -1

In the quantum coding language the string operators, with curves making complete loops around the torus, define 4 logical operators which act on the state of the product qubits in the 2^2 -degenerate groundspace.

APPENDIX: ENTANGLEMENT ENTROPY

Suppose we have a system in d spacial dimensions with a local Hamiltonian \hat{H} and a groundstate $|G\rangle$. Consider a region of the space, A , which we would like to calculate a quantity which characterizes how entangled those degrees of freedom are with the outside region.

We can partition the field theory Hilbert space⁹ $\mathcal{H} = \mathcal{H}_A \otimes \mathcal{H}_{\bar{A}}$, where \bar{A} denotes the complement of A . One can compute the reduced density matrix associated with $|G\rangle$ on A as well the entanglement entropy $S(A)$:

$$\rho_A = \text{tr}_{\bar{A}} |G\rangle\langle G| \quad \rightarrow \quad S(A) = -\text{Tr} [\rho_A \log \rho_A] \quad (5)$$

where in principle these traces can be computed using the path-integral formalism.¹⁰ This quantity $S(A)$ delivers the goods; in the example of N spins in singlet states along the boundary $S(A) = N \log 2$. In general we expect the degrees of freedom on A to be entangled and $S(A) \neq 0$. In fact $S(A)$ will naively diverge!

⁹ This partitioning for a theory with a gauge field is far less clear and requires care

¹⁰ For interacting theories a great deal of tricks have been developed

Such a situation arises from the infinite degrees of freedom along the boundary ∂A . This is common in field theory and demands a choice of UV regulator, like a lattice spacing $\epsilon \approx \frac{1}{\Lambda}$. Once done however one sees an organized structure to the divergences with coefficients sometimes containing scheme independent data about the theory.

For a generic gapped field theory the entanglement entropy obeys an 'area' law:

$$S(A) = g_{d-1} \frac{|\partial A|^{d-1}}{\epsilon^{d-1}} + g_{d-2} \frac{|\partial A|^{d-2}}{\epsilon^{d-2}} + \dots + g_0 \log \epsilon + S_f \quad (6)$$

where g_i are coefficients which may or may be dependent on microscopic details and S_f is some finite contribution such as the 'topological' entanglement entropy in certain $D = 2 + 1$ dimensional systems.

This has been rigorously established at least in the case of $D = 1 + 1$ dimensional systems where 6 implies $S(A) = g_0 n \log \epsilon$ where g_0 is independent of the size of the spatial region and n is the number of connected regions composing A ; we're tracking the number of cuts![2]

For the case of a $D = 1 + 1$ conformal field theory, where the system is gapless, the leading universal term is:

$$S(A) = \frac{c_L + c_R}{6} \log \frac{L}{\epsilon} \quad (7)$$

where we are imagining A is a line of length L and (c_L, c_R) is the central charge.

Additionally the entanglement entropy satisfies a relation known as 'strong subadditivity':

$$S(A) + S(B) \geq S(A \cup B) + S(A \cap B) \quad (8)$$

where B is some different region of the space. Such an equality one might expect given we've called $S(A)$ an entropy.

-
- [1] Robert Alicki, Mark Fannes, and Michal Horodecki. On thermalization in kitaev's 2d model. *Journal of Physics A: Mathematical and Theoretical*, 42(6):065303, 2009.
 - [2] Itai Arad, Alexei Kitaev, Zeph Landau, and Umesh Vazirani. An area law and sub-exponential algorithm for 1d systems. *arXiv preprint arXiv:1301.1162*, 2013.
 - [3] Parsa Bonderson, Alexei Kitaev, and Kirill Shtengel. Detecting non-abelian statistics in the nu= 5/2 fractional quantum hall state. *arXiv preprint cond-mat/0508616*, 2005.
 - [4] Sergey Bravyi and Jeongwan Haah. Analytic and numerical demonstration of quantum self-correction in the 3d cubic code. *arXiv preprint arXiv:1112.3252*, 2011.
 - [5] Sergey Bravyi and Jeongwan Haah. Energy landscape of 3d spin hamiltonians with topological order. *Physical review letters*, 107(15):150504, 2011.
 - [6] Sergey Bravyi and Barbara Terhal. A no-go theorem for a two-dimensional self-correcting quantum memory based on stabilizer codes. *New Journal of Physics*, 11(4):043029, 2009.
 - [7] Claudio Castelnovo and Claudio Chamon. Entanglement and topological entropy of the toric code at finite temperature. *Physical Review B*, 76(18):184442, 2007.
 - [8] Eric Dennis, Alexei Kitaev, Andrew Landahl, and John Preskill. Topological quantum memory. *Journal of Mathematical Physics*, 43(9):4452–4505, 2002.
 - [9] Jeongwan Haah. Local stabilizer codes in three dimensions without string logical operators. *Physical Review A*, 83(4):042330, 2011.
 - [10] Matthew B Hastings, Grant H Watson, and Roger G Melko. Self-correcting quantum memories beyond the percolation threshold. *arXiv preprint arXiv:1309.2680*, 2013.
 - [11] Isaac H Kim. Long-range entanglement is necessary for a topological storage of quantum information. *Physical review letters*, 111(8):080503, 2013.
 - [12] A Yu Kitaev. Fault-tolerant quantum computation by anyons. *Annals of Physics*, 303(1):2–30, 2003.
 - [13] Alexei Kitaev and Chris Laumann. Topological phases and quantum computation. *arXiv preprint arXiv:0904.2771*, 2009.
 - [14] Alexei Kitaev and John Preskill. Topological entanglement entropy. *Physical review letters*, 96(11):110404, 2006.
 - [15] Dalimil Mazáč and Alioscia Hamma. Topological order, entanglement, and quantum memory at finite temperature. *Annals of Physics*, 327(9):2096–2111, 2012.
 - [16] Zohar Nussinov and Gerardo Ortiz. Autocorrelations and thermal fragility of anyonic loops in topologically quantum ordered systems. *Physical Review B*, 77(6):064302, 2008.
 - [17] CW von Keyserlingk, FJ Burnell, and Steven H Simon. Three-dimensional topological lattice models with surface anyons. *Physical Review B*, 87(4):045107, 2013.
 - [18] Beni Yoshida. Feasibility of self-correcting quantum memory and thermal stability of topological order. *Annals of Physics*, 326(10):2566–2633, 2011.
 - [19] Beni Yoshida. Exotic topological order in fractal spin liquids. *Physical Review B*, 88(12):125122, 2013.
 - [20] Yi Zhang, Tarun Grover, and Ashvin Vishwanath. Entanglement entropy of critical spin liquids. *Physical review letters*, 107(6):067202, 2011.